

N-CHANNEL ENHANCEMENT MODE POWER MOSFET

MAIN CHARACTERISTICS

I_D	10A
V_{DSS}	500V
$R_{DS(ON)-typ}(@V_{GS}=10V)$	0.56Ω

FEATURES

- ◆Fast Switching
- ◆Low ON Resistance
- ◆Low Gate Charge
- ◆100% Single Pulse avalanche energy Test
- ◆LeadfreeincomplywithEUROHS2011/65/EUdirectives

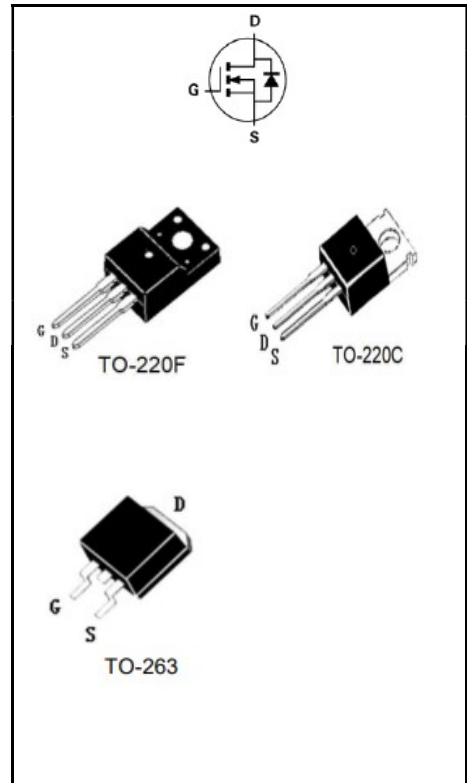

MECHANICAL DATA

- ◆Case: Molded plastic
- ◆Mounting Position: Any
- ◆Molded Plastic: UL Flammability Classification Rating 94V-0
- ◆Solder bath temperature275℃ maximum,10s per JESD22-106
- ◆Case:TO-220C, TO-220F, TO-263

PRODUCT SPECIFICATION CLASSIFICATION

Part Number	Package	Marking	Pack
YFW10N50A9	TO-220C	10N50AC	50PCS/Tube
YFW10N50A2	TO-220F(0.5mm)	10N50AF	50PCS/Tube
YFW10N50A8	TO-220F(1.3mm)	10N50AF	50PCS/Tube
YFW10N50A3	TO-263	10N50AS	50PCS/Tube
YFW10N50A3-R	TO-263	10N50AS	800PCS/Tape

Maximum Ratings at Tc=25°C unless otherwise specified

Characteristics	Symbols	Value			Units
		220C	220F	263	
Drain-Source Voltage	V_{DS}	500			V
Gate-Source Voltage	V_{GS}	±30			V
Continue Drain Current-Continuous (TC = 25°C)	I_D	10			A
-Continuous (TC = 100°C)		6			
Pulsed Drain Current (Note1)	I_{DM}	40			A
Power Dissipation	P_D	143	48	140	W
-Derate above 25°C		1.14	0.38	1.14	
Single Pulse Avalanche Energy (Note2)	E_{AS}	650			mJ
Avalanche Current (Note 1)	I_{AR}	10			A
Repetitive Avalanche Energy (Note 1)	E_{AS}	14			mJ
Operating Temperature Range	T_J	150			°C
Storage Temperature Range	T_{STG}	-55 to +150			°C
Thermal Resistance, Junction to Case	$R_{\theta JC}$	0.92	2.68	0.92	°C/W
Thermal Resistance, Junction to Ambient	$R_{\theta JA}$	62.5	62.5	62.5	°C/W

Maximum Ratings at Tc=25°C unless otherwise specified

Characteristics	Test Condition	Symbols	Min	Typ	Max	Units
Drain-Source Breakdown Voltage	$V_{GS} = 0 V, I_D = 250 \mu A$	BV_{DSS}	500	-	-	V
Drain-Source Leakage Current	$V_{DS} = 500 V, V_{GS} = 0 V$	I_{DSS}	-	-	1	uA
	$V_{DS} = 400 V, T_c = 125^\circ C$		-	-	10	
Gate Leakage Current	$V_{GS} = \pm 30 V, V_{DS} = 0 V$	I_{GSS}	-	-	±100	nA
Gate-Source Threshold Voltage	$V_{DS} = V_{GS}, I_D = 250 \mu A$	$V_{GS(th)}$	2	-	4	V
Drain-Source On-State Resistance	$V_{GS} = 10 V, I_D = 5 A$	$R_{DS(on)}$	-	0.56	0.68	Ω
Forward Transconductance(Note3)	$V_{DS} = 40 V, I_D = 5 A$	g_{fs}	-	10	-	S
Input Capacitance	$V_{GS} = 0 V, V_{DS} = 25 V, f = 1MHz$	C_{iss}	-	1100	-	pF
Output Capacitance		C_{oss}	-	156	-	
Reverse Transfer Capacitance		C_{rss}	-	7	-	
Turn-on Delay Time	$I_D = 10 A, V_{DD} = 250 V, R_G = 25\Omega(\text{Note3,4})$	$td(ON)$	-	25	-	nS
Rise Time		tr	-	20	-	
Turn-Off Delay Time		$td(OFF)$	-	50	-	
Fall Time		tf	-	20	-	
Total Gate Charge	$I_D = 10 A, V_{DD} = 400V, V_{GS} = 10 V(\text{Note3,4})$	Q_G	-	32	-	nC
Gate to Source Charge		Q_{GS}	-	8	-	
Gate to Drain Charge		Q_{GD}	-	12	-	

Source-Drain Diode Characteristics at Ta=25°C unless otherwise specified

Characteristics	Test Condition	Symbols	Min	Typ	Max	Units
Maximum Continuous Drain-Source Diode Forward Current		I_S	-	-	10	A
Maximum Pulsed Drain-Source Diode Forward Current		I_{SM}	-	-	40	A
Drain-Source Diode Forward Voltage	$I_{SD} = 10\text{ A}$	V_{SD}	-	-	1.4	V
Reverse Recovery Time	$I_{SD} = 10\text{ A}, V_{GS} = 0\text{ V},$ $dI_F / dt = 100\text{ A}/\mu\text{s}$ (Note3)	trr	-	398	-	nS
Reverse Recovery Charge		Q_{rr}	-	2.5	-	uC

Note:

1. Repetitive Rating: Pulse width limited by maximum junction temperature.
2. $I_{AS} = 10\text{ A}, V_{DD} = 50\text{ V}, L = 12\text{mH}, R_G = 25\Omega,$ starting $T_J = 25^\circ\text{C}.$
3. ulse test: Pulse Width $\leq 300\ \mu\text{s},$ Duty Cycle $\leq 2\%.$
4. Essentially Independent of Operating Temperature.

RATINGS AND CHARACTERISTIC CURVES

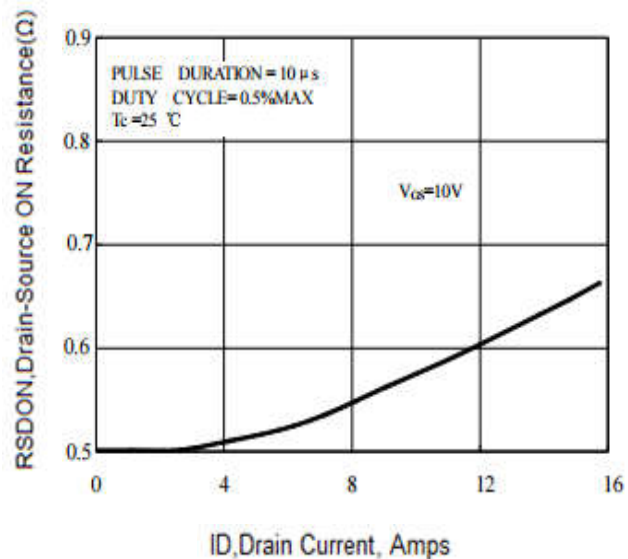
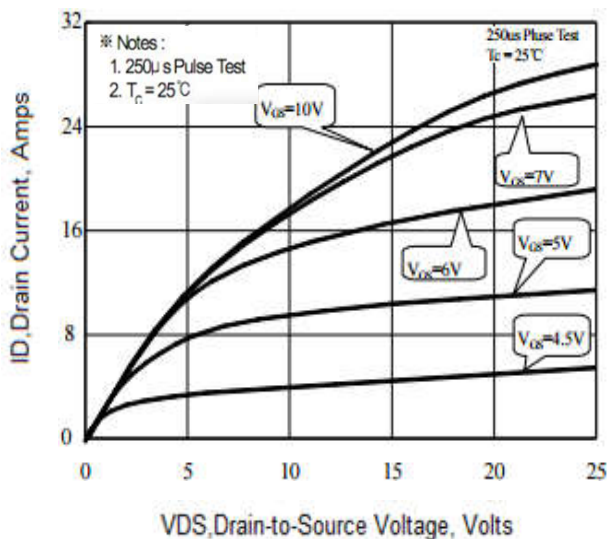
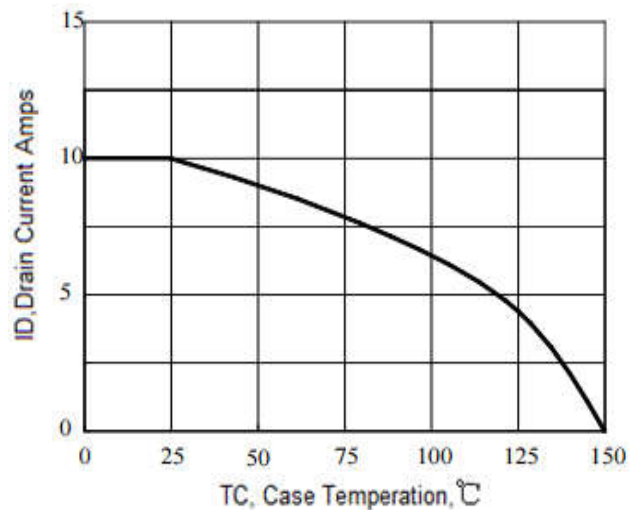
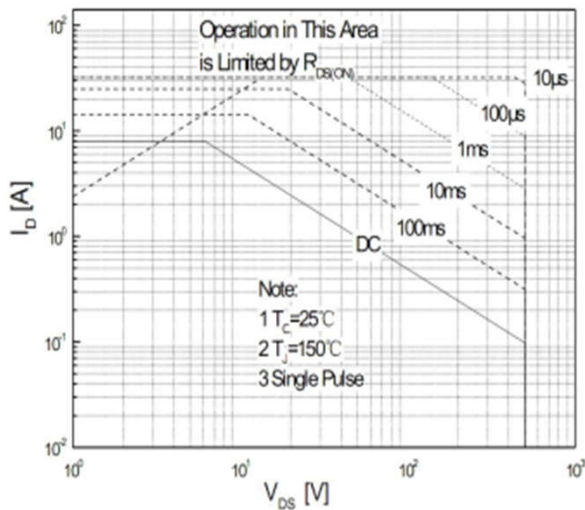

RATINGS AND CHARACTERISTIC CURVES

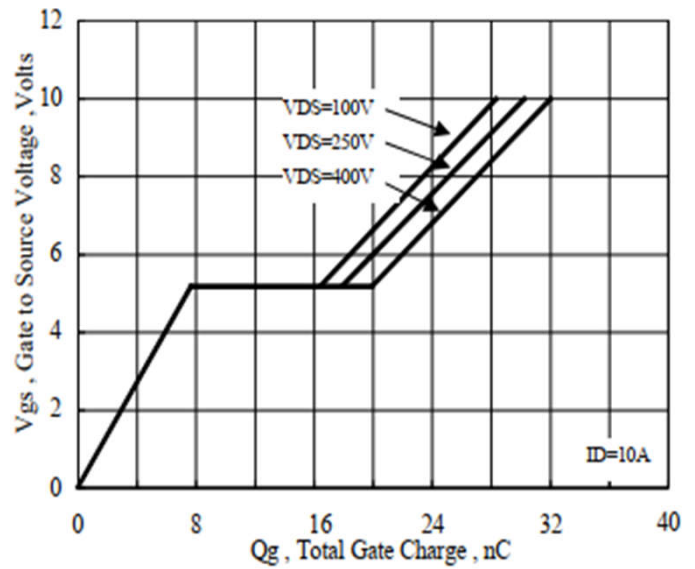
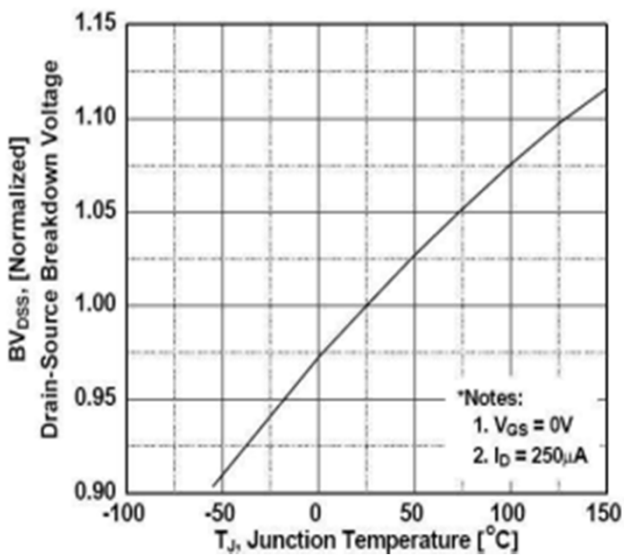
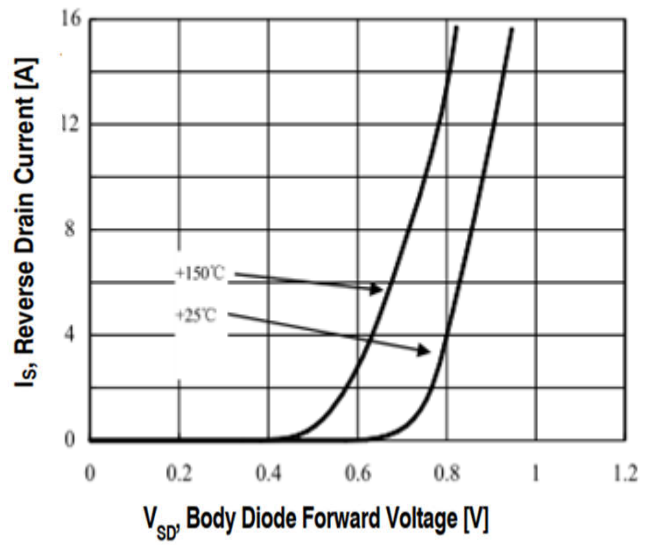
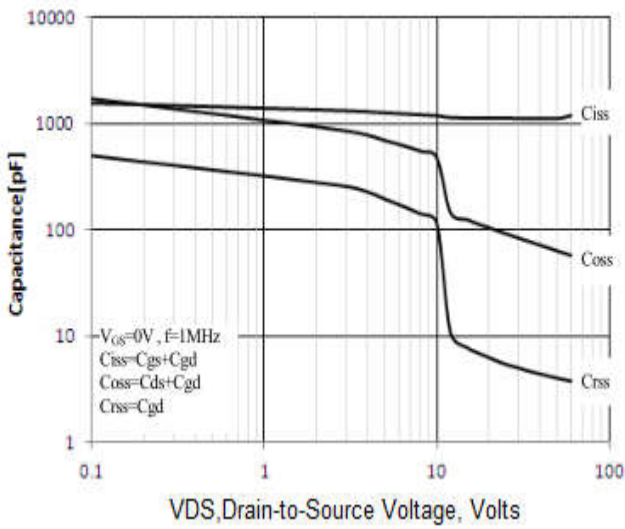

Package Outline Dimensions millimeters

TO-220C

Dim.	Min.	Max.
A	9.8	10.2
A2	4.8	5.2
C	4.35	4.65
C1	1.45	1.05
D	0.65	0.95
E	3.45	3.75
F	2.85	3.15
G	6.4	6.8
H	0.35	0.65
J	28.68	28.98
K	2.8	3.2
M	1.15	1.45
N	Typical 2.54	
P	2.2	2.6
Q	9	9.4
S	0.15	0.35
U	2.65	2.95
DIA	宽1.50±0.10 深0.50 MAX	
All Dimensions in millimeter		

TO-220F

Dim.	Min.	Max.
A	9.95	10.25
B	2.95	3.25
C	1.25	1.45
D	12.95	13.25
E	0.50	0.65
F	3.1	3.3
G	1.30	1.45
H	Typ 2.54	
I	Typ 5.08	
J	4.60	4.75
K	2.50	2.65
L	6.35	6.55
M	15.4	16.0
N	2.75	3.05
O	0.48	0.52
P	0.76	0.84
All Dimensions in millimeter		

Package Outline Dimensions millimeters

TO-263

