

SCHOTTKY BARRIER RECTIFIER

Reverse Voltage - 200 V

Forward Current - 30 A

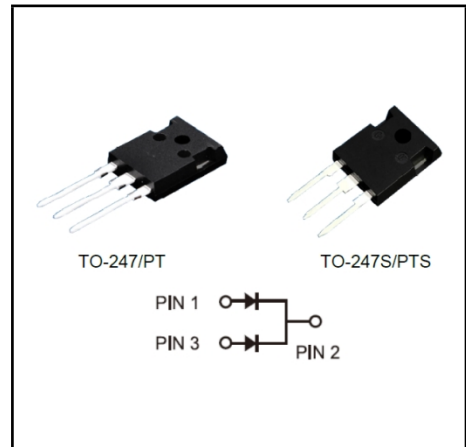

FEATURES

- ◆ Low forward voltage
- ◆ High current capability
- ◆ High forward surge capability
- ◆ Low power losses · High efficiency
- ◆ Guarding for over voltage protection
- ◆ Lead free in comply with EU RoHS 2011/65/EU directives

MECHANICAL DATA

- ◆ Case: TO-247/PT TO-247/PTS
- ◆ Solder bath temperature 275°C maximum, 10s per JESD22-106

Primary Characteristic

I_o	2*15A
V_{RRM}	200V
I_{FSM}	220A
V_F	0.74V
T_J Max	175°C

Maximum Ratings (Per Leg) at Ta=25°C unless otherwise specified

Parameter	Symbols	Value	Units
Maximum Repetitive Peak Reverse Voltage	V_{RRM}	200	V
Maximum RMS voltage	V_{RMS}	200	V
Maximum DC Blocking Voltage	V_{DC}	200	V
Maximum Average Forward Rectified Current	Per Leg	15	A
	Total	30	
Peak Forward Surge Current, 8.3ms Single Half Sine-wave	I_{FSM}	220	A
Operating Temperature Range	T_J	-50 ~ +175	°C
Storage Temperature Range	T_{STG}	-50 ~ +175	°C
Typical Thermal Resistance (Note1) TO-247PT, TO-247PTS	$R_{\theta JA}$ / $R_{\theta JC}$	2	°C/W

Note1: Thermal resistance from Junction to case per leg mounted on heatsink.

Electrical Characteristics (Per Leg) unless otherwise specified

Characteristics	Symbols	Value		Units	
		Typ	Max		
Forward Voltage Drop(Note2) at $I_F=3A$ at $I_F=5A$ at $I_F=15A$	V_F	TA=25°C	0.70	-	V
		TA=125°C	0.55	-	
		TA=25°C	0.74	-	
		TA=125°C	0.60	-	
		TA=25°C	0.86	0.89	
		TA=125°C	0.74	-	
Maximum Reverse Current at $V_R=200V$	I_R	TA=25°C	2	20	uA
		TA=125°C	0.3	-	mA

Note2: Pulse test: 300 μs pulse width, 1 % duty cycle

RATINGS AND CHARACTERISTIC CURVES

FIG.1 MAXIMUM FORWARD CURRENT DERATING CURVE

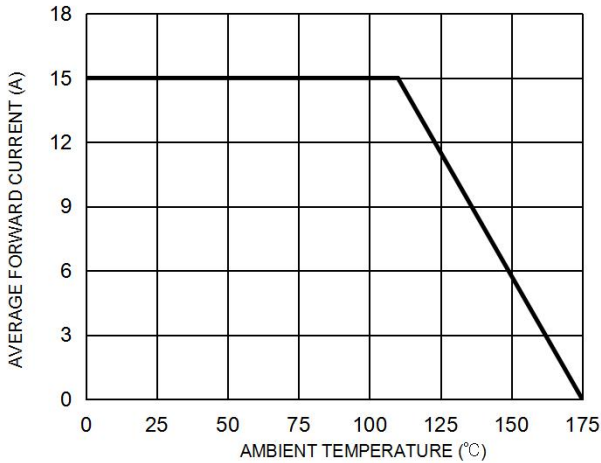

FIG. 2 MAXIMUM NON-REPETITIVE FORWARD SURGE CURRENT PER LEG

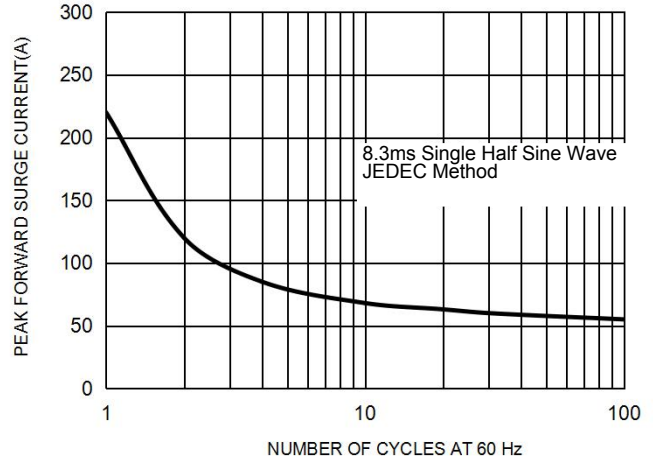

FIG. 3 TYPICAL FORWARD CHARACTERISTICS PER LEG

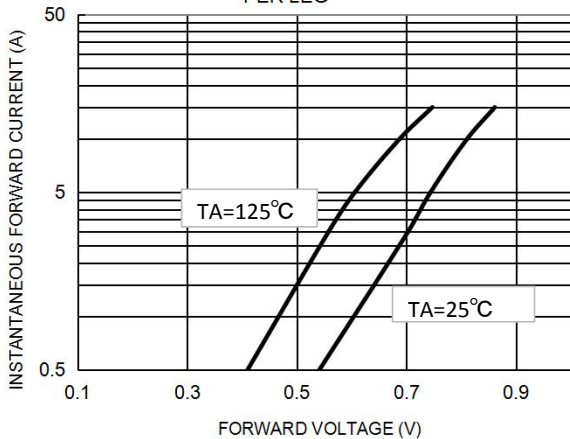
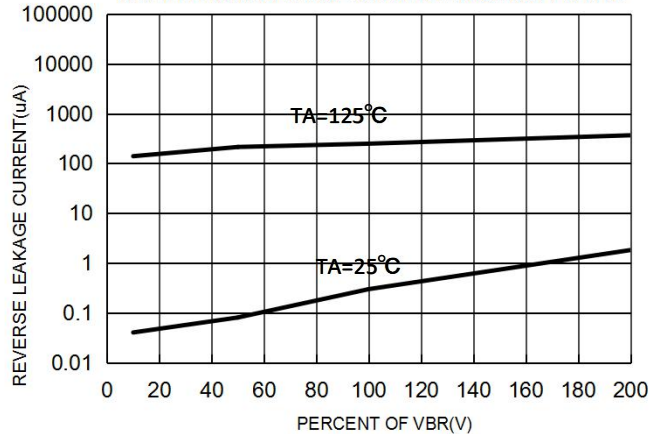
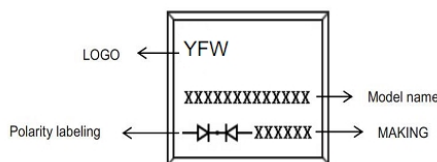

FIG. 4 TYPICAL REVERSE CHARACTERISTICS PER LEG



Marking on the body



MAKING:

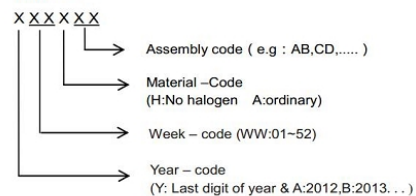

Ordering information

Part Number	Package	Unit Weight	Base Quantity	Delivery mode
HRT30L200PT	TO-247	0.209oz(5.93g)	30 pcs / tube	600pcs/box 2400pcs/carton
HRT30L200PTS	TO-247S	0.158oz(4.48g)	30 pcs / tube	600pcs/box 2400pcs/carton

Note: For Halogen Free molding compound, add "H" suffix to part number above.

Package Outline Dimensions millimeters

TO-247

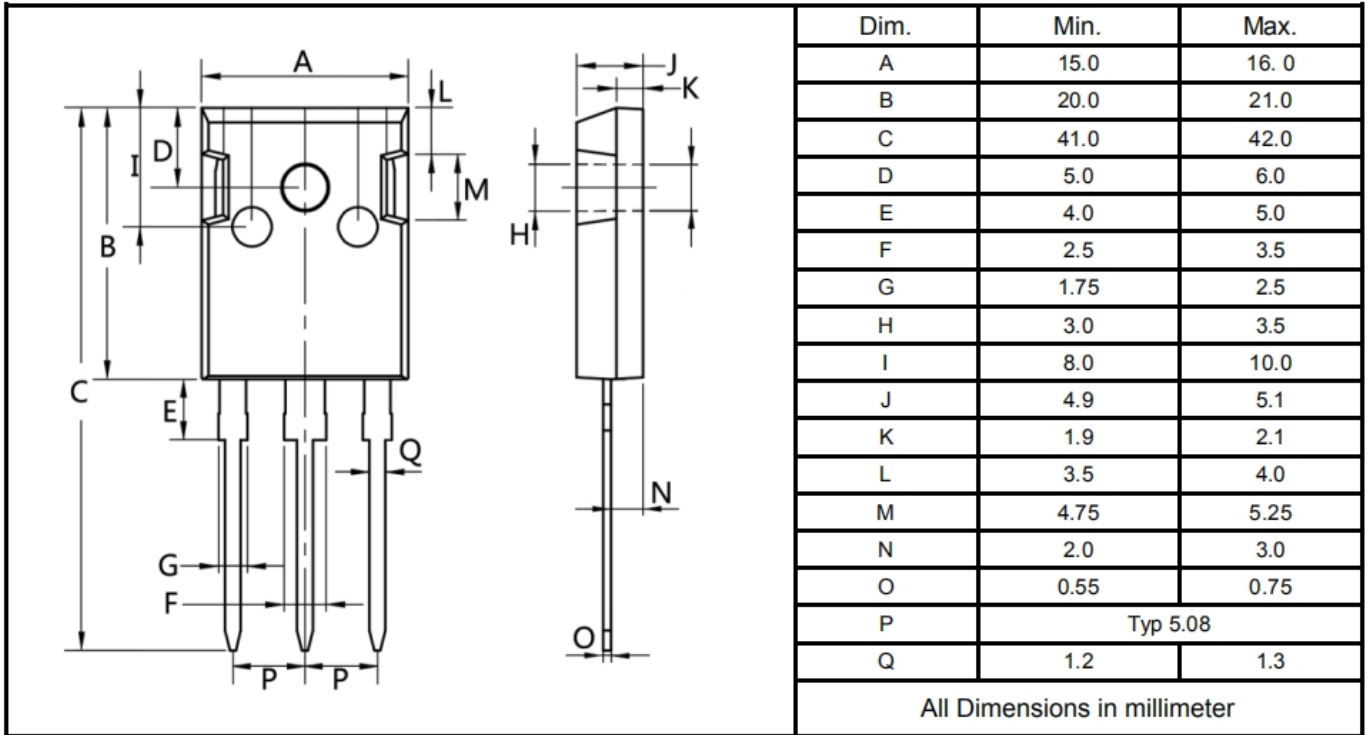

TO-247S

